



**Hidro  
Pnevmo  
Tehnika**

3, Vojeli St., Kazanlak, Bulgaria  
Tel.: +359 431/ 62 228, 68 440  
e-mail : info@hpt-bg.com  
www.hpt-bg.com

## VALVE BLOCKS

### BPC5/ ...

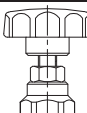
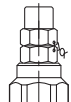

All performances and calibration are carried out by using hydraulic oil with viscosity approx. 46 cSt at 50 °C  
Temperature range: -20 °C...+80 °C.  
Filtration absolute: 20 µm

Code	Adjustment
<b>A</b>	Leakproof hex. socket screw 
<b>B</b>	Handknob and locknut 
<b>C</b>	Sealing cap 

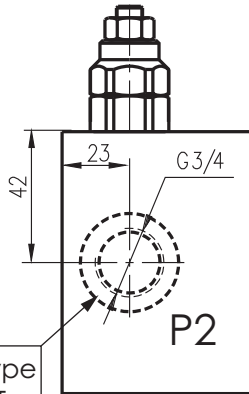
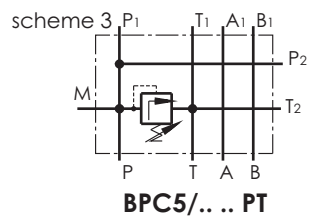
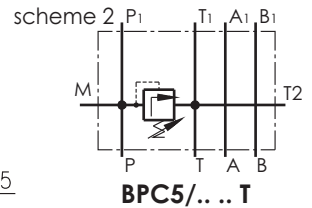
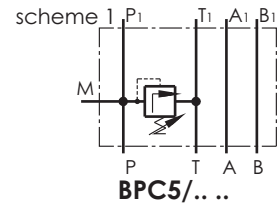
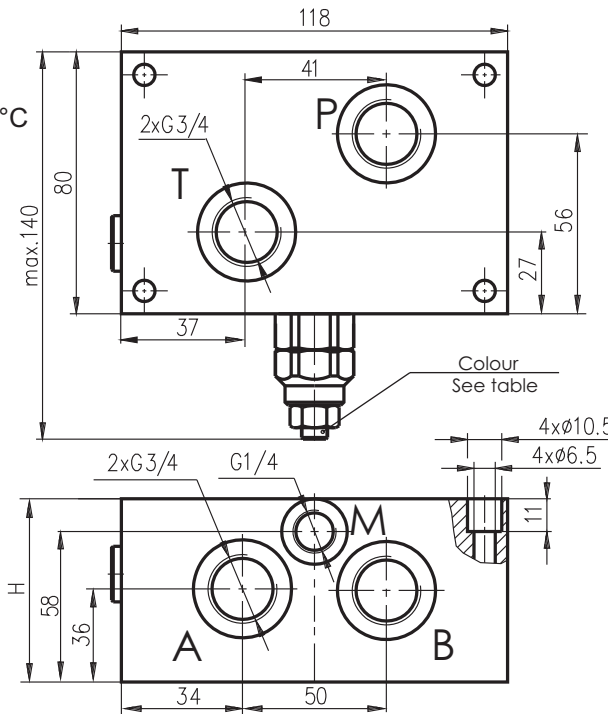

Only for type BPC5/...PT

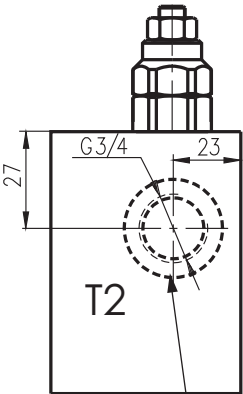
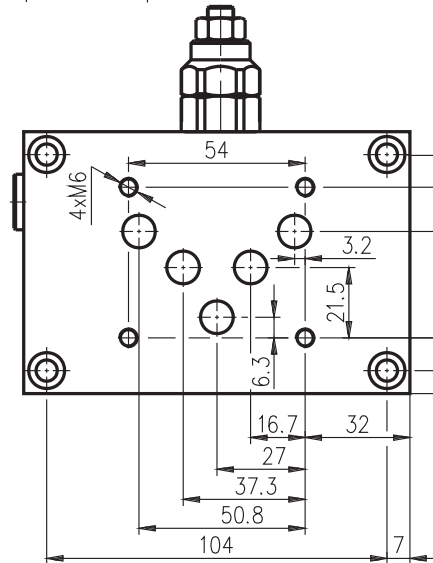

Only for type BPC5/...T  
BPC5/...PT

Pressure range			
Code	Standard setting bar (Q=5l/min)	Adj. pressure range bar	Colour
<b>10</b>	80	10...100	White
<b>25</b>	180	30...250	Yellow
<b>35</b>	250	70...350	Black

Type	P <sub>max.</sub> bar	Q <sub>max.</sub> L/min	H mm
<b>BPC5/... ..</b>	350	80	58
<b>BPC5/... .. T</b>	350	80	58
<b>BPC5/... .. PT</b>	350	80	68

## ORDERING CODE

### BPC5 / 25 A T

